

# CEILING FIXTURES

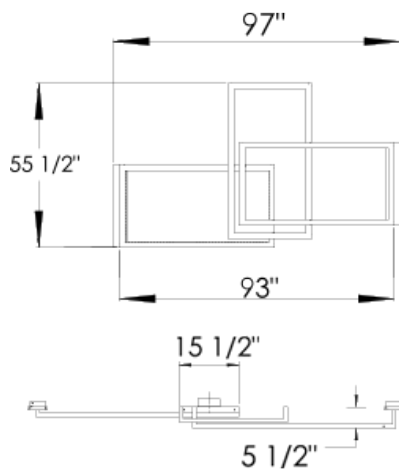



# MODEL 1685



**DIMENSIONS:**

H: 5 1/2" D: 55 1/2" W: 97"

**FINISH SHOWN:**

Statuary Bronze

**SHADE MATERIAL SHOWN:**

Opal Matte Acrylic

**LAMPING:**

 **L108-30K** 108 Watts, 3000K LED



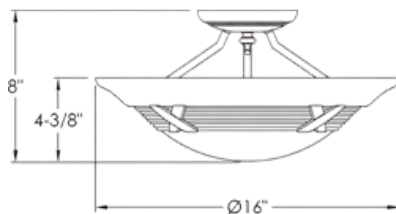

**DIMENSIONS:**

**H: 8" Dia: 16"**

**FINISH SHOWN:**

**OBZ Oxidized Bronze**

**SHADE MATERIAL SHOWN:**

**Antique French Glass**

**LAMPING:**

**(2)**  **C13E** 13 Watt Quad Tube Compact Fluorescent 4 Pin Electronic, G24Q-1 Base

**(3)**  **Medium** Base Socket, for LED A Style Bulb or Self-Ballasted CFL



# MODEL 2137

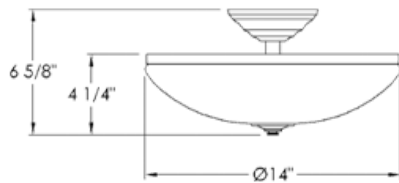

#### DIMENSIONS:

H: 6 5/8" Dia: 14"

#### FINISH SHOWN:

**PB** Polished Brass

#### ALSO AVAILABLE IN:

**PC** Polished Chrome

**SN** Satin Nickel

**SDB** Standard Bronze

#### SHADE MATERIAL SHOWN:

Hand Blown Morie Glass

#### LAMPING:

(2)  **C13E** 13 Watt Quad Tube Compact Fluorescent 4 Pin Electronic, G24Q-1 Base

(2)  **Medium** Base Socket, for LED A Style Bulb or Self-Ballasted CFL





# MODEL 2144

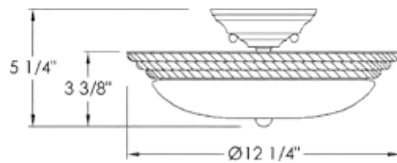

#### DIMENSIONS:

H: 5 1/4" Dia: 12 1/4"

#### FINISH SHOWN:

**OBZ** Oxidized Bronze

#### ALSO AVAILABLE IN:

**SN** Satin Nickel

**ANTB** Antique Brass

**SDB** Standard Bronze

#### SHADE MATERIAL SHOWN:

Antique Glass

#### ALSO AVAILABLE IN:

Opal Matte Acrylic

#### LAMPING:

(2)  **B60** 60 Watt Medium Base Torpedo

(2)  **C13E** 13 Watt Quad Tube Compact

Fluorescent 4 Pin Electronic, G24Q-1 Base





# MODEL 2147

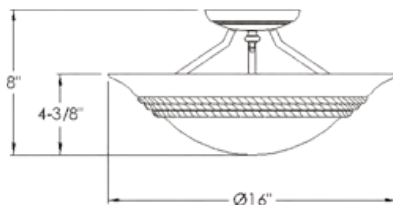

#### DIMENSIONS:

H: 8" Dia: 16"

#### FINISH SHOWN:

**PB** Polished Brass

#### ALSO AVAILABLE IN:

**OBZ** Oxidized Bronze

**PB** Polished Brass

**PC** Polished Chrome

**SN** Satin Nickel

#### SHADE MATERIAL SHOWN:

Opal Matte Glass

#### LAMPING:

(2)  **C13E** 13 Watt Quad Tube Compact

Fluorescent 4 Pin Electronic, G24Q-1 Base

(3)  **Medium** Base Socket, for LED A Style

Bulb or Self-Ballasted CFL





# MODEL 2149

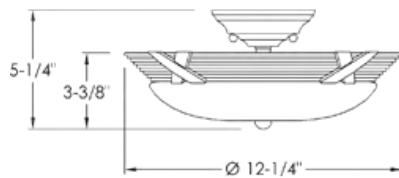

#### DIMENSIONS:

H: 5 1/4" Dia: 12 1/4"

#### FINISH SHOWN:

Verde Banding with Polished Brass Bundle Trim

ALSO AVAILABLE IN:

**SN** Satin Nickel

**SDB** Standard Bronze

#### SHADE MATERIAL SHOWN:

Antique Glass

ALSO AVAILABLE IN:

Opal Matte Acrylic

#### LAMPING:

(2)  **C13E** 13 Watt Quad Tube Compact

Fluorescent 4 Pin Electronic, G24Q-1 Base

(2)  **B60** 60 Watt Medium Base Torpedo





# MODEL 2150



#### DIMENSIONS:

H: 6 1/2" Dia: 22"

#### FINISH SHOWN:

**SN** Satin Nickel

#### SHADE MATERIAL SHOWN:

Opal Matte Acrylic

#### LAMPING:

(2)  **C13E** 13 Watt Quad Tube Compact  
Fluorescent 4 Pin Electronic, G24Q-1 Base

(2)  **C26E** 26 Watt Quad Tube Compact  
Fluorescent 4 Pin Electronic, G24Q-3 Base

(2)  **Medium** Base Socket, for LED A Style  
Bulb or Self-Ballasted CFL

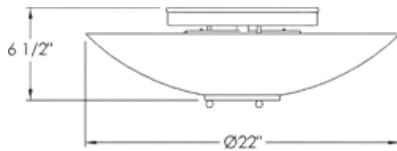





# MODEL 2158

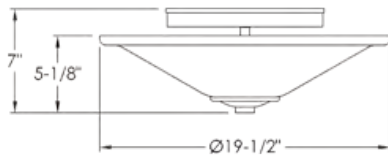

#### DIMENSIONS:

H: 5 1/8" Dia: 19 1/2"

#### FINISH SHOWN:

**PB** Polished Brass

#### ALSO AVAILABLE IN:

**SN** Satin Nickel

**PC** Polished Chrome

**SDB** Standard Bronze

#### SHADE MATERIAL SHOWN:

Hand Blown Morie Glass

#### LAMPING:

(2)  **C13E** 13 Watt Quad Tube Compact Fluorescent 4 Pin Electronic, G24Q-1 Base

(2)  **C26E** 26 Watt Quad Tube Compact Fluorescent 4 Pin Electronic, G24Q-3 Base

(2)  **Medium** Base Socket, for LED A Style Bulb or Self-Ballasted CFL





# MODEL 2174

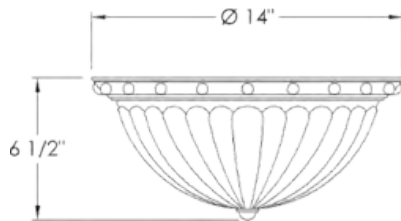

**DIMENSIONS:**

H: 6 1/2" Dia: 14"

**FINISH SHOWN:**

**OBZ** Oxidized Bronze

**ALSO AVAILABLE IN:**

**SN** Satin Nickel

**ANTB** Antique Brass

**SHADE MATERIAL SHOWN:**

Antique White

**LAMPING:**

(2)  **C13E** 13 Watt Quad Tube Compact Fluorescent 4 Pin Electronic, G24Q-1 Base

(2)  **Medium** Base Socket, for LED A Style Bulb or Self-Ballasted CFL





# MODEL 2200

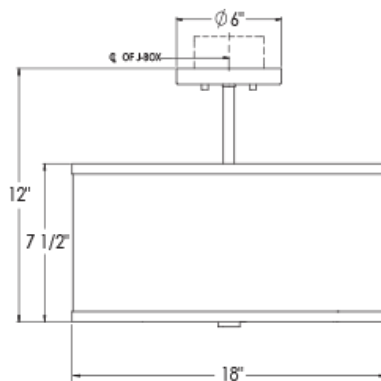

#### DIMENSIONS:

H: 12" Dia: 18"

#### FINISH SHOWN:

**SA** Satin Aluminum

#### ALSO AVAILABLE IN:

**SN** Satin Nickel

**SDB** Standard Bronze

#### SHADE MATERIAL SHOWN:

Canvas White Linen

#### SHADE SIZE:

H: 7 1/2" Dia: 18"

#### LAMPING:

(2)  **GU24** Base Socket, for LED A Style Bulb  
or Self-Ballasted CFL

 **L18-30K** 18 Watts, 3000K LED





# MODEL 2203

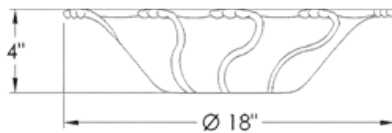

#### DIMENSIONS:

H: 4" Dia: 18"

#### FINISH SHOWN:

**EPG** Etched Piastra Glass

#### SHADE MATERIAL SHOWN:

Hand Formed Piastra Glass

#### LAMPING:

(2)  **C13E** 13 Watt Quad Tube Compact  
Fluorescent 4 Pin Electronic, G24Q-1 Base

(2)  **Medium** Base Socket, for LED A Style  
Bulb or Self-Ballasted CFL





# MODEL 2210

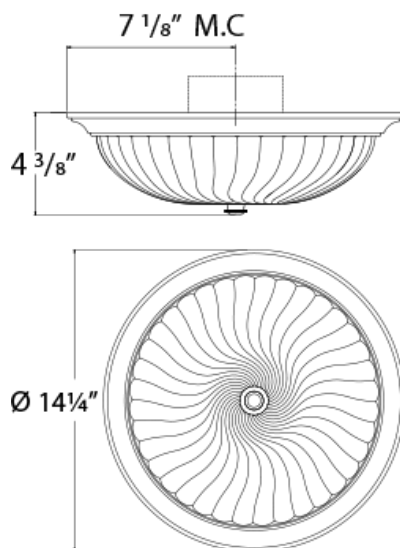

#### DIMENSIONS:

H: 4 3/8" Dia: 14 1/4"

#### FINISH SHOWN:

**OBZ** Oxidized Bronze

#### ALSO AVAILABLE IN:

**SN** Satin Nickel

**ANTB** Antique Brass

#### SHADE MATERIAL SHOWN:

Frosted Glass

#### LAMPING:

(2)  **C13E** 13 Watt Quad Tube Compact

Fluorescent 4 Pin Electronic, G24Q-1 Base

(2)  **B60** 60 Watt Medium Base Torpedo

 **L18-30K** 18 Watts, 3000K LED





## MODEL 2211-12

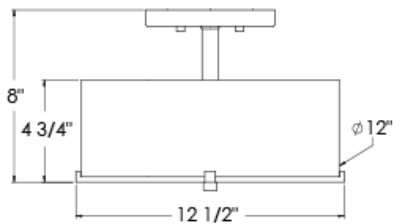

#### DIMENSIONS:

H: 8" Dia: 12 1/2"

#### FINISH SHOWN:

**PBZ** Polished Bronze

#### ALSO AVAILABLE IN:

**SDB** Standard Bronze

**SN** Satin Nickel

#### SHADE MATERIAL SHOWN:

Opal Matte Acrylic

#### LAMPING:

(2)  **GU24** Base Socket, for LED A Style Bulb  
or Self-Ballasted CFL





# MODEL 2213

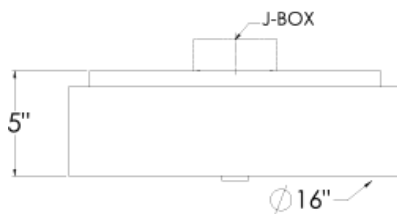

#### DIMENSIONS:

H: 5" Dia: 16"

#### FINISH SHOWN:

**BS** Brushed Stainless Steel

#### SHADE MATERIAL SHOWN:

Opal Matte Acrylic

#### LAMPING:

(2)  **C26E** 26 Watt Quad Tube Compact  
Fluorescent 4 Pin Electronic, G24Q-3 Base

(3)  **GU24** Base Socket, for LED A Style Bulb  
or Self-Ballasted CFL

 **L18-30K** 18 Watts, 3000K LED





# MODEL 2218

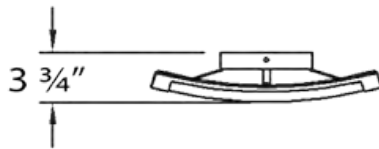

#### DIMENSIONS:

H: 3 3/4" D: 16" W: 16"

#### FINISH SHOWN:

SN Satin Nickel

#### SHADE MATERIAL SHOWN:

Opal Matte Acrylic

#### LAMPING:

(2)  C13E 13 Watt Quad Tube Compact

Fluorescent 4 Pin Electronic, G24Q-1 Base

(2)  **Medium** Base Socket, for LED A Style

Bulb or Self-Ballasted CFL







# MODEL 2224



#### DIMENSIONS:

H: 32" Dia: 5"

#### FINISH SHOWN:

**PDBL** Powder Coated Black

Gold Interior

#### LAMPING:

(1)  **Medium** Base Socket, for LED A Style Bulb or Self-Ballasted CFL





# MODEL 2242

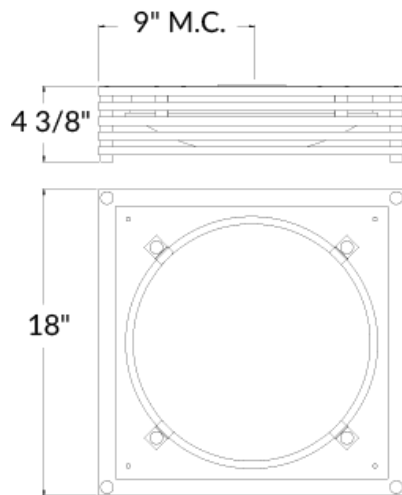

#### DIMENSIONS:

H: 4 3/8" D: 18" W: 18"

#### FINISH SHOWN:

**DSW** Dark Stained Wood

**PC** Polished Chrome

#### SHADE MATERIAL SHOWN:

Opal Matte Glass

#### LAMPING:

(2)  **C13E** 13 Watt Quad Tube Compact  
Fluorescent 4 Pin Electronic, G24Q-1 Base

(2)  **C26E** 26 Watt Quad Tube Compact  
Fluorescent 4 Pin Electronic, G24Q-3 Base

(2)  **B60** 60 Watt Medium Base Torpedo

 **L18-30K** 18 Watts, 3000K LED





# MODEL 2297

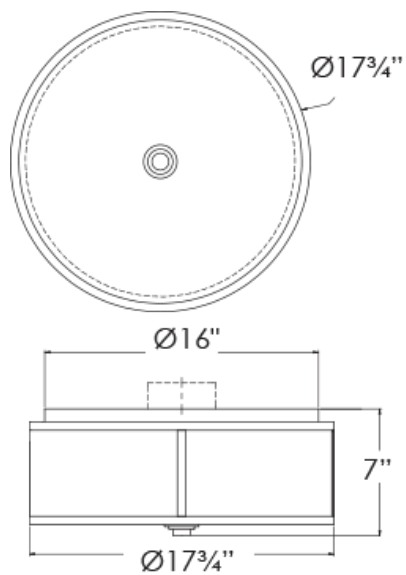

#### DIMENSIONS:

H: 7" Dia: 17 3/4"

#### FINISH SHOWN:

**PN** Polished Nickel

#### ALSO AVAILABLE IN:

**SN** Satin Nickel

**ANTB** Antique Brass

**SDB** Standard Bronze

#### SHADE MATERIAL SHOWN:

Opal Matte Acrylic

#### LAMPING:

(2)  **C18E** 18 Watt Quad Tube Compact

Flourescent 4 Pin Electronic, G24Q-2 Base

(2)  **GU24** Base Socket, for LED A Style Bulb

or Self-Ballasted CFL

 **L18-30K** 18 Watts, 3000K LED





# MODEL 2299

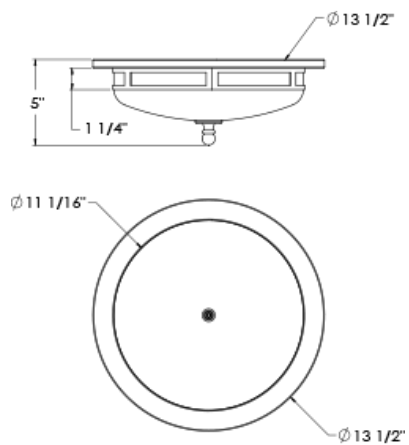

DIMENSIONS:  
H: 5" Dia: 13 1/2"  
FINISH SHOWN:  
AGB Aged Brass

LAMPING:  
(2)  E-12 Socket for Candelabra Base





# MODEL 2300

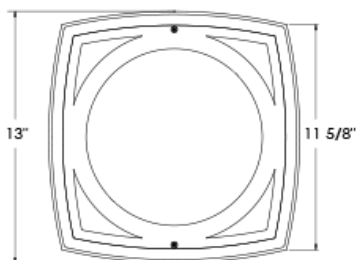
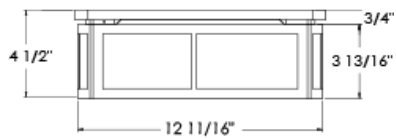

**DIMENSIONS:**

H: 4 1/2" D: 13" W: 13"

**FINISH SHOWN:**

**AGB Aged Brass**

**SHADE MATERIAL SHOWN:**

Opal Matte Acrylic Diffuser

**LAMPING:**

(2)  E-12 Socket for Candelabra Base





# MODEL 2316

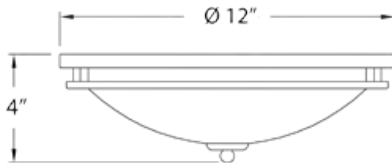

**DIMENSIONS:**

**H: 4" Dia: 12"**

**FINISH SHOWN:**

**PC Polished Chrome**

**ALSO AVAILABLE IN:**

**SN Satin Nickel**

**ANTB Antique Brass**

**SHADE MATERIAL SHOWN:**

**Opal Matte Acrylic**

**LAMPING:**

 **L12-30K** 12 Watts, 3000K LED





# MODEL 2336

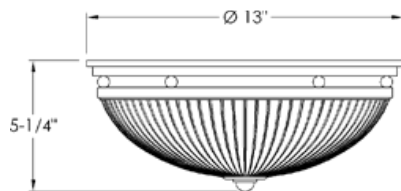

#### DIMENSIONS:

H: 5 1/4" Dia: 13"

#### FINISH SHOWN:

**SN** Satin Nickel

#### SHADE MATERIAL SHOWN:

Frosted Glass

#### LAMPING:

(2)  **C13E** 13 Watt Quad Tube Compact  
Fluorescent 4 Pin Electronic, G24Q-1 Base

(2)  **GU24** Base Socket, for LED A Style Bulb  
or Self-Ballasted CFL





# MODEL 2338

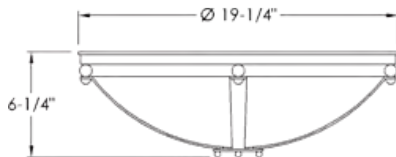

#### DIMENSIONS:

H: 6 1/4" Dia: 19 1/4"

#### FINISH SHOWN:

**OBZ** Oxidized Bronze

#### ALSO AVAILABLE IN:

**SN** Satin Nickel

**ANTB** Antique Brass

#### SHADE MATERIAL SHOWN:

Opal Matte Acrylic

#### LAMPING:

(2)  **C13E** 13 Watt Quad Tube Compact Fluorescent 4 Pin Electronic, G24Q-1 Base

(2)  **C26E** 26 Watt Quad Tube Compact Fluorescent 4 Pin Electronic, G24Q-3 Base

(2)  **Medium** Base Socket, for LED A Style Bulb or Self-Ballasted CFL







# MODEL 2348

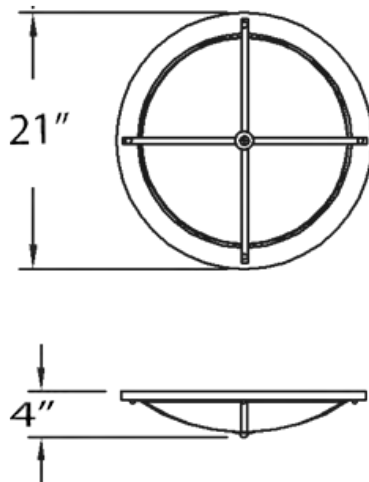

#### DIMENSIONS:

H: 4" Dia: 21"

#### FINISH SHOWN:

**PA** Polished Aluminum

#### ALSO AVAILABLE IN:

**PB** Polished Brass

**PC** Polished Chrome

**PN** Polished Nickel

**SA** Satin Aluminum

**SC** Satin Chrome

#### SHADE MATERIAL SHOWN:

Opal Matte Acrylic

#### LAMPING:

(2)  **C26E** 26 Watt Quad Tube Compact  
Fluorescent 4 Pin Electronic, G24Q-3 Base

(2)  **CF18** 18 Watt Biax Compact Fluorescent  
Electronic 2G11 Base





# MODEL 2373

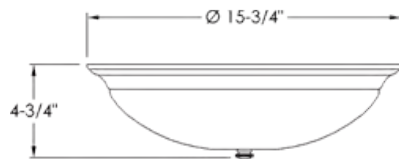

#### DIMENSIONS:

H: 4 3/4" Dia: 15 3/4"

#### FINISH SHOWN:

**PA** Polished Aluminum

#### ALSO AVAILABLE IN:

**SN** Satin Nickel

**ANTB** Antique Brass

**SDB** Standard Bronze

#### SHADE MATERIAL SHOWN:

Hand Blown Morie Glass

#### LAMPING:

(2)  **C13E** 13 Watt Quad Tube Compact Fluorescent 4 Pin Electronic, G24Q-1 Base

(2)  **B60** 60 Watt Medium Base Torpedo

 **L18-30K** 18 Watts, 3000K LED





## MODEL 2379

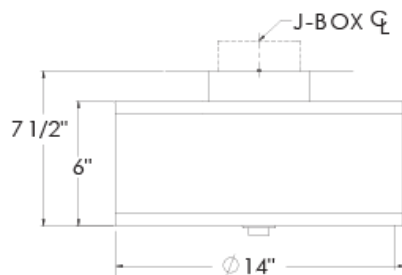

**DIMENSIONS:**

**H:** 7 1/2" **Dia:** 14"

**FINISH SHOWN:**

**PC** Polished Chrome

**ALSO AVAILABLE IN:**

**SN** Satin Nickel

**ANTB** Antique Brass

**SHADE MATERIAL SHOWN:**

Opal Matte Glass

**LAMPING:**

**(2)**  **GU24** Base Socket, for LED A Style Bulb  
or Self-Ballasted CFL





# MODEL 2380

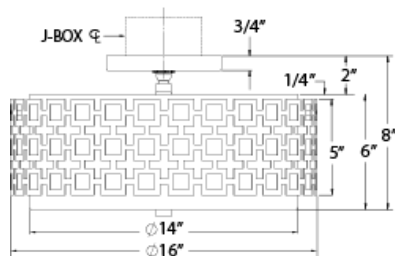

#### DIMENSIONS:

H: 8" Dia: 16"

#### FINISH SHOWN:

**SB** Satin Brass

#### ALSO AVAILABLE IN:

**SN** Satin Nickel

#### SHADE MATERIAL SHOWN:

Opal Matte Glass

#### LAMPING:

(2)  **GU24** Base Socket, for LED A Style Bulb or Self-Ballasted CFL





# MODEL 2388

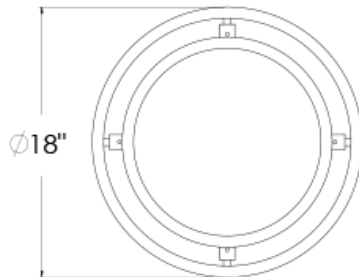
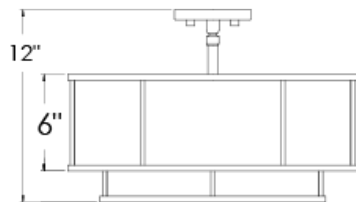

**DIMENSIONS:**

H: 12" Dia: 18"

**FINISH SHOWN:**

**PC Polished Chrome**

**SHADE MATERIAL SHOWN:**

Shantung White

**LAMPING:**

(2)  **GU24** Base Socket, for LED A Style Bulb  
or Self-Ballasted CFL





# MODEL 2397

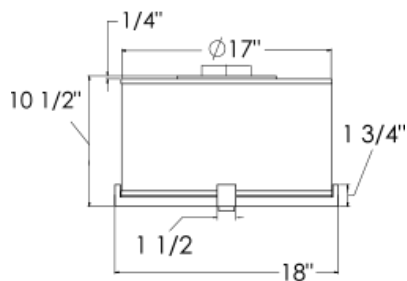

#### DIMENSIONS:

H: 10 1/2" Dia: 18"

#### FINISH SHOWN:

**SB** Satin Brass

#### ALSO AVAILABLE IN:

**SN** Satin Nickel

**ANTB** Antique Brass

#### SHADE MATERIAL SHOWN:

CD Ivory Linen

#### LAMPING:

(3)  **Medium** Base Socket, for LED A Style Bulb or Self-Ballasted CFL

(3)  **GU24** Base Socket, for LED A Style Bulb or Self-Ballasted CFL

 **L12-27K** 12 Watts, 2700K LED





# MODEL 2398

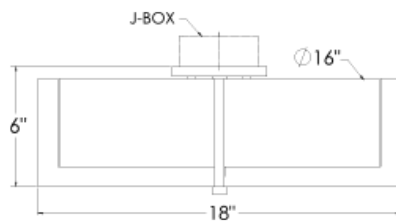

#### DIMENSIONS:

H: 6" Dia: 18"

#### FINISH SHOWN:

**BA** Brushed Aluminum

#### ALSO AVAILABLE IN:

**SN** Satin Nickel

**ANTB** Antique Brass

#### SHADE MATERIAL SHOWN:

CD Ivory Linen with an Opal Matte Acrylic Bottom Diffuser

#### SHADE SIZE:

H: 4 3/8" Dia: 16"

#### LAMPING:

(2)  **Medium** Base Socket, for LED A Style Bulb or Self-Ballasted CFL





# MODEL 2403

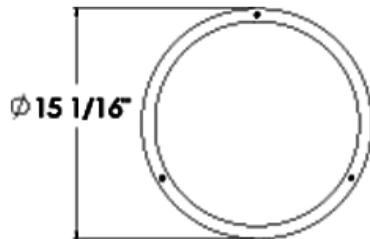

#### DIMENSIONS:

H: 6 1/4" Dia: 15 1/6"

#### FINISH SHOWN:

Powder Coated Gloss Black

#### SHADE MATERIAL SHOWN:

with an Opal Matte Acrylic Bottom Diffuser

#### LAMPING:

(3)  GU24 Base Socket, for LED A Style Bulb  
or Self-Ballasted CFL







# MODEL 2409

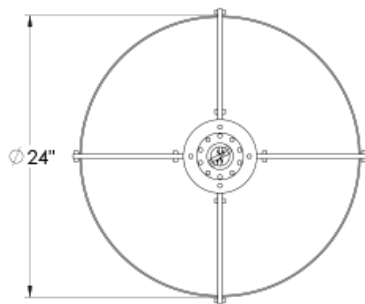
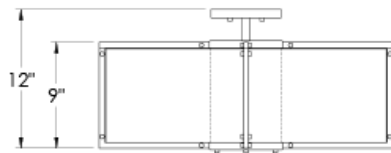

**DIMENSIONS:**

H: 12" Dia: 24"

**FINISH SHOWN:**

**BZ** Bronze

**ALSO AVAILABLE IN:**

**SN** Satin Nickel

**ANTB** Antique Brass

**SHADE MATERIAL SHOWN:**

Clear Acrylic Opal Matte Acrylic

**LAMPING:**

**(1)**  **GU24** Base Socket, for LED A Style Bulb or Self-Ballasted CFL





# MODEL 2410

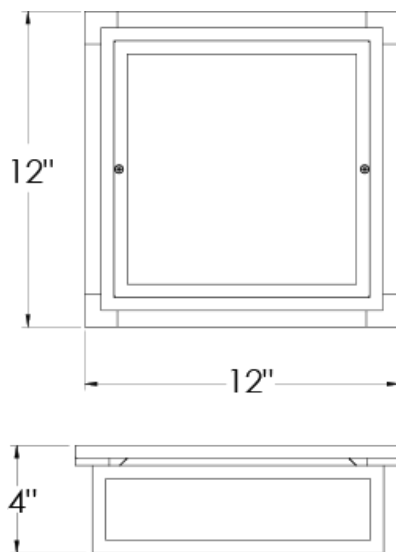

**DIMENSIONS:**

H: 4" D: 12" W: 12"

**FINISH SHOWN:**

**PC Polished Chrome**

**SHADE MATERIAL SHOWN:**

Opal Matte Acrylic

**LAMPING:**

(1)  **GU24** Base Socket, for LED A Style Bulb  
or Self-Ballasted CFL





# MODEL 2420

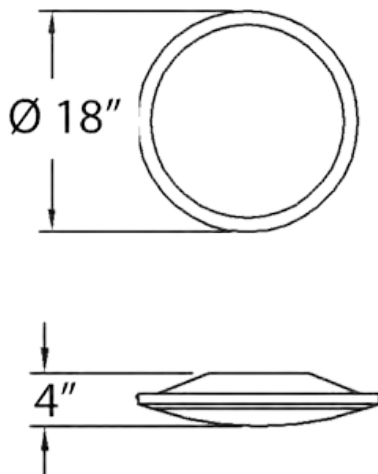

#### DIMENSIONS:

H: 4" Dia: 18"

#### FINISH SHOWN:

**SC** Satin Chrome

#### ALSO AVAILABLE IN:

**SN** Satin Nickel

**ANTB** Antique Brass

**SDB** Standard Bronze

#### SHADE MATERIAL SHOWN:

Opal Matte Acrylic

#### LAMPING:

(2)  **C13E** 13 Watt Quad Tube Compact  
Fluorescent 4 Pin Electronic, G24Q-1 Base

(2)  **GU24** Base Socket, for LED A Style Bulb  
or Self-Ballasted CFL





# MODEL 2425

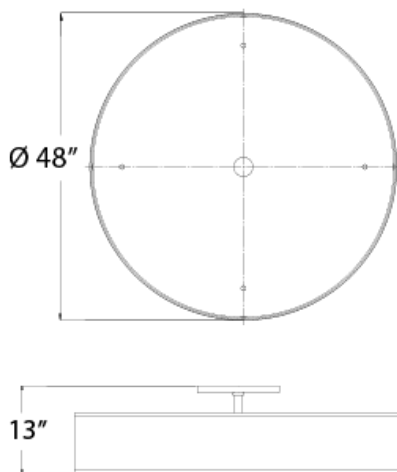

**DIMENSIONS:**

**H:** 13" **Dia:** 48"

**FINISH SHOWN:**

**SN** Satin Nickel

**ALSO AVAILABLE IN:**

**ANTB** Antique Brass

**SDB** Standard Bronze

**SHADE MATERIAL SHOWN:**

Off White Linen

**LAMPING:**

**(8)**  **GU24** Base Socket, for LED A Style Bulb or Self-Ballasted CFL

**(8)**  **Medium** Base Socket, for LED A Style Bulb or Self-Ballasted CFL





# MODEL 2443

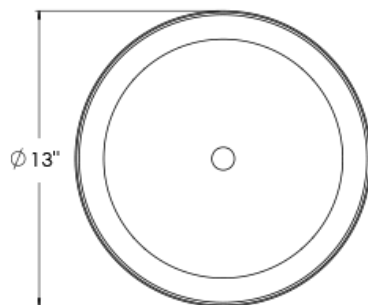
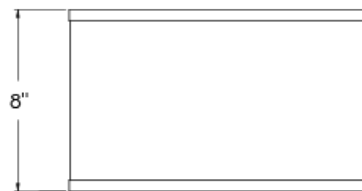

#### DIMENSIONS:

H: 8" Dia: 13"

#### FINISH SHOWN:

**BN** Brushed Nickel

#### SHADE MATERIAL SHOWN:

Black Leatherete Shade with Gold Interior with an Opal Matte Acrylic Bottom Diffuser

#### LAMPING:

(2)  **GU24** Base Socket, for 18 Watt Quad CFL





# MODEL 2455

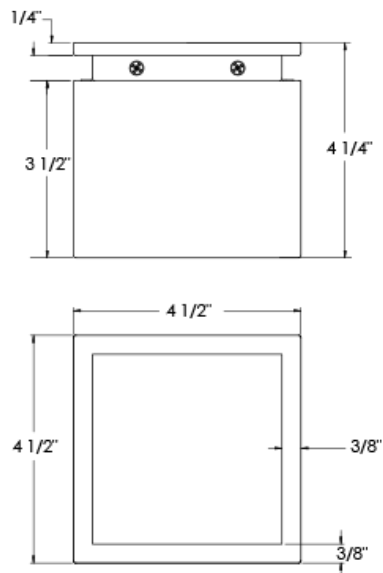

#### DIMENSIONS:

H: 4 1/4" D: 4 1/2" W: 4 1/2"

#### FINISH SHOWN:

**PDMW** Powder Coated Matte White

#### SHADE MATERIAL SHOWN:

Frosted Glass

#### LAMPING:

(1)  **L12-27K** 12 Watts, 2700K LED





# MODEL 2480

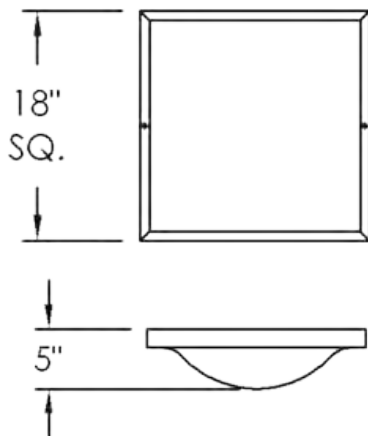

#### DIMENSIONS:

H: 5" D: 18" W: 18"

#### FINISH SHOWN:

**SA** Satin Aluminum

#### ALSO AVAILABLE IN:

**ANTB** Antique Brass

#### SHADE MATERIAL SHOWN:

Opal Matte Acrylic

#### LAMPING:

(2)  **CF18** 18 Watt Biax Compact Fluorescent  
Electronic 2G11 Base

 **L24-30K** 24 Watts, 3000K LED





# MODEL 2483

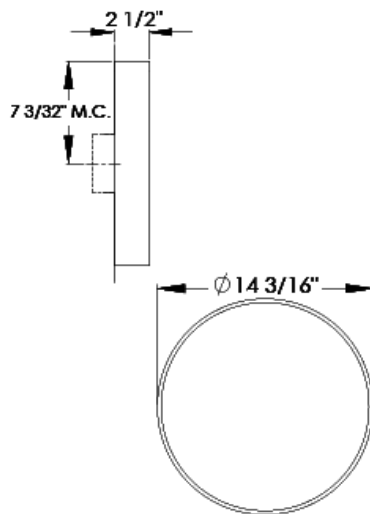

#### DIMENSIONS:

H: 2 1/2" Dia: 14 3/16"

#### FINISH SHOWN:

Powder Coated Revere Pewter

#### SHADE MATERIAL SHOWN:

Opal Matte Acrylic

#### LAMPING:

 **L18-27K** 18 Watts, 2700K LED







# MODEL 2508

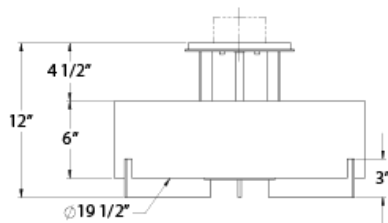

**DIMENSIONS:**

H: 12" Dia: 19 1/2"

**FINISH SHOWN:**

**PDDS** Powder Coated Dark Smoke

**SHADE MATERIAL SHOWN:**

Opal Matte Acrylic

**LAMPING:**

(3)  **GU24** Base Socket, for LED A Style Bulb  
or Self-Ballasted CFL





# MODEL 2515

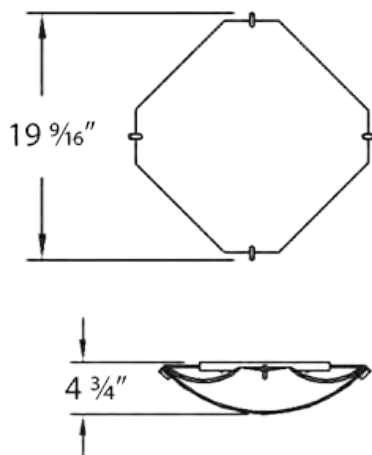

#### DIMENSIONS:

H: 4 3/4" D: 19 9/16" W: 19 9/16"

#### FINISH SHOWN:

**PC** Polished Chrome

#### ALSO AVAILABLE IN:

**SN** Satin Nickel

**ANTB** Antique Brass

#### SHADE MATERIAL SHOWN:

Opal Matte Glass

#### LAMPING:

(2)  **Medium** Base Socket, for LED A Style Bulb or Self-Ballasted CFL

(2)  **C13E** 13 Watt Quad Tube Compact Fluorescent 4 Pin Electronic, G24Q-1 Base

(2)  **C26E** 26 Watt Quad Tube Compact Fluorescent 4 Pin Electronic, G24Q-3 Base

 **L18-30K** 18 Watts, 3000K LED





# MODEL 2530

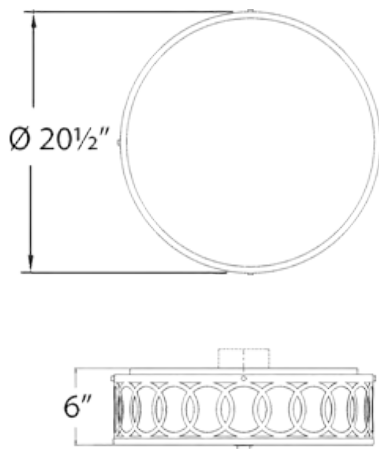

#### DIMENSIONS:

H: 6" Dia: 20 1/2"

#### FINISH SHOWN:

PC Polished Chrome

#### SHADE MATERIAL SHOWN:

Opal Matte Acrylic

#### LAMPING:

(4)  **C18E** 18 Watt Quad Tube Compact  
Flourescent 4 Pin Electronic, G24Q-2 Base

(4)  **GU24** Base Socket, for LED A Style Bulb  
or Self-Ballasted CFL

 **L18-30K** 18 Watts, 3000K LED





## MODEL 2532

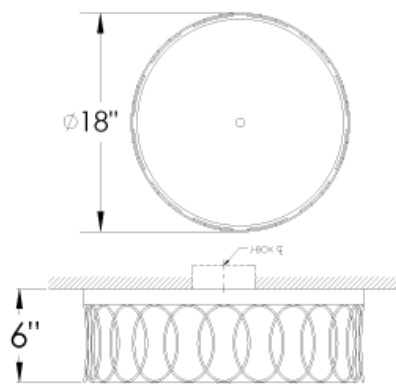

#### DIMENSIONS:

H: 6" Dia: 18"

#### FINISH SHOWN:

**ANTB** Antique Brass

#### SHADE MATERIAL SHOWN:

Opal Matte Acrylic Diffuser

#### SHADE SIZE:

H: 5" Dia: 17"

#### LAMPING:

(1)  **Medium** Base Socket, for LED A Style Bulb or Self-Ballasted CFL





# MODEL 2538

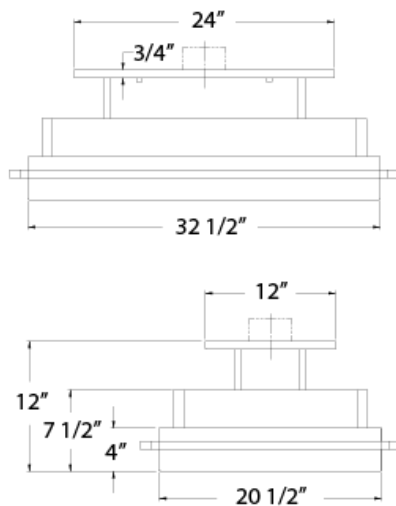

#### DIMENSIONS:

H: 12" D: 24" W: 36"

#### FINISH SHOWN:

**BZ** Bronze

#### SHADE MATERIAL SHOWN:

White Art Glass

#### LAMPING:

(6)  **Medium** Base Socket, for LED A Style Bulb or Self-Ballasted CFL





# MODEL 2541



**DIMENSIONS:**

H: 17" Dia: 19"

**FINISH SHOWN:**

**BB** Brushed Brass

**SHADE MATERIAL SHOWN:**

Hardback Off White Shantung

**LAMPING:**

(3)  **Medium** Base Socket, for LED A Style Bulb or Self-Ballasted CFL

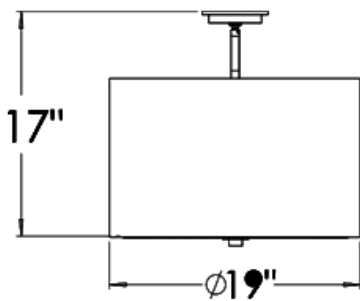



# MODEL 2542

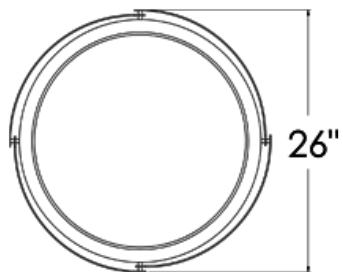
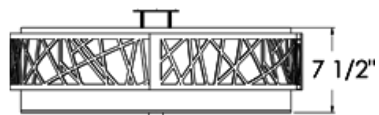

**DIMENSIONS:**

H: 7 1/2" Dia: 26"

**FINISH SHOWN:**

Distressed Gold

**SHADE MATERIAL SHOWN:**

Opal Matte Acrylic

**LAMPING:**

(4)  GU24 Base Socket, for LED A Style Bulb  
or Self-Ballasted CFL





# MODEL 2547

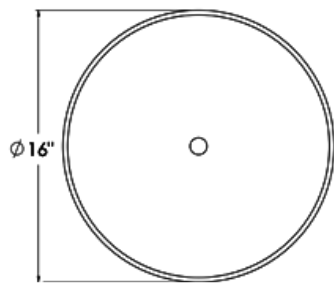
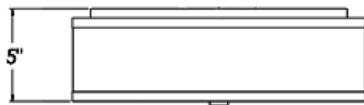

**DIMENSIONS:**

H: 5" Dia: 16"

**FINISH SHOWN:**

**BZ** Bronze

**SHADE MATERIAL SHOWN:**

Brussels Cream with an Opal Matte Acrylic Bottom  
Diffuser

**LAMPING:**

(2)  **GU24** Base Socket, for LED A Style Bulb  
or Self-Ballasted CFL





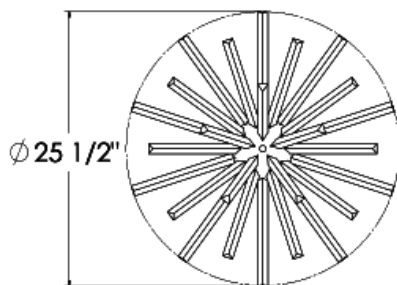
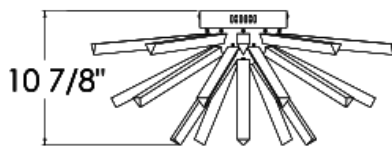

DIMENSIONS:

H: 10 7/8" Dia: 25 1/2"

FINISH SHOWN:

**SB** Satin Brass

SHADE MATERIAL SHOWN:

Triangular Clear Acrylic Rods Satin Brass Dome

Diffuser

LAMPING:

 **L18-27K** 18 Watts, 2700K LED



# MODEL 2553

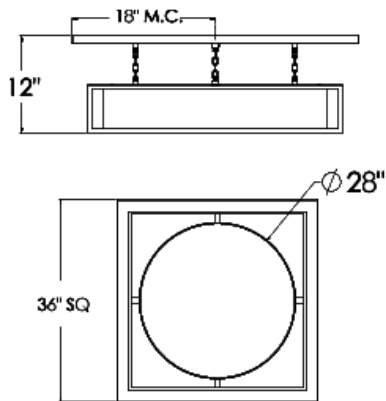

#### DIMENSIONS:

H: 12" D: 36" W: 36"

#### FINISH SHOWN:

**AGB** Aged Brass

#### SHADE MATERIAL SHOWN:

Brussels Cream with Glossy White Acrylic Bottom  
Diffuser

#### SHADE SIZE:

H: 6" Dia: 28"

#### LAMPING:

(4)  **GU24** Base Socket, for LED A Style Bulb  
or Self-Ballasted CFL





# MODEL 2569

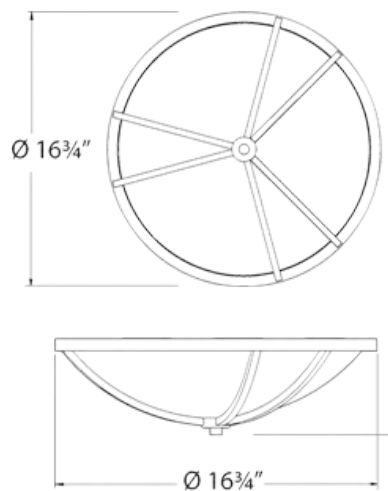

#### DIMENSIONS:

H: 5" Dia: 16 3/4"

#### FINISH SHOWN:

**BA** Brushed Aluminum

#### ALSO AVAILABLE IN:

**SN** Satin Nickel

#### SHADE MATERIAL SHOWN:

Opal Matte Acrylic

#### LAMPING:

(2)  **C13E** 13 Watt Quad Tube Compact Fluorescent 4 Pin Electronic, G24Q-1 Base

(2)  **GU24** Base Socket, for LED A Style Bulb or Self-Ballasted CFL

 **L18-27K** 18 Watts, 2700K LED





# MODEL 2599

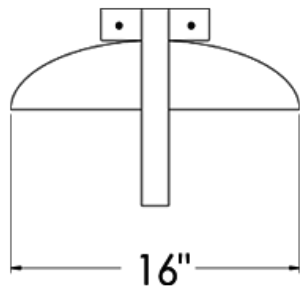
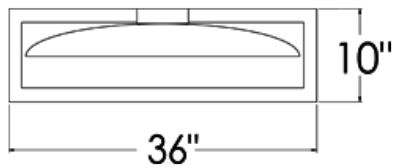

**DIMENSIONS:**

H: 10" D: 16" W: 36"

**FINISH SHOWN:**

**PDMB** Powder Coated Matte Black

**SHADE MATERIAL SHOWN:**

**PDMW** Powder Coated Matte White

**LAMPING:**

 **L10-27K** 10 Watts, 2700K LED





# MODEL 2617

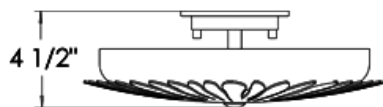
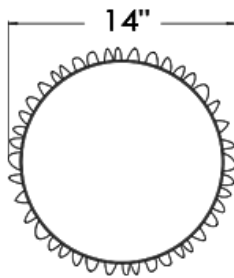

**DIMENSIONS:**

H: 4 1/2" Dia: 14"

**FINISH SHOWN:**

**BB** Brushed Brass

**SHADE MATERIAL SHOWN:**

Opal Matte Acrylic Diffuser

**LAMPING:**

(3)  E-12 Socket for Candelabra Base





# MODEL 2623

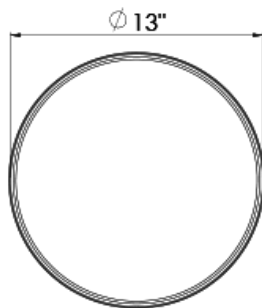
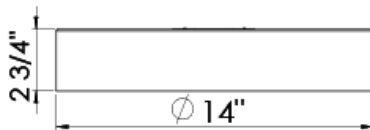

#### DIMENSIONS:

H: 2 3/4" Dia: 14"

#### FINISH SHOWN:

**Wh** Powder Coated White

#### SHADE MATERIAL SHOWN:

Opal Matte Glass

#### ADDITIONAL NOTES:

Luminaire is 120V Only

#### LAMPING:

 **L15-30K** 15 Watts, 3000K LED, 800

Lumens





# MODEL 2624

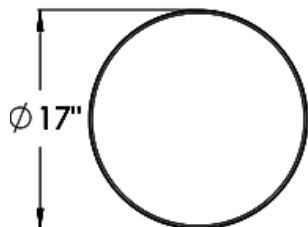
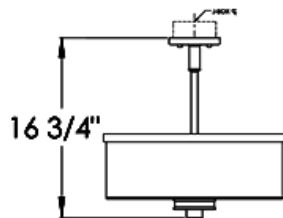

#### DIMENSIONS:

H: 16 3/4" Dia: 17"

#### FINISH SHOWN:

**PDBZ** Powder Coated Bronze

#### SHADE MATERIAL SHOWN:

Opal Matte Acrylic

#### LAMPING:

(3)  GU24 Base Socket, for LED A Style Bulb  
or Self-Ballasted CFL





# MODEL 2635

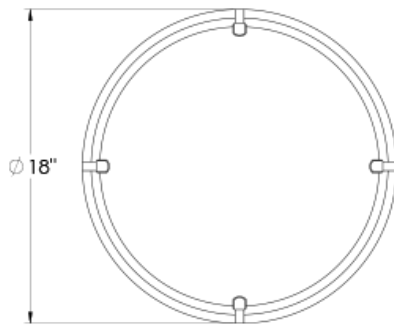
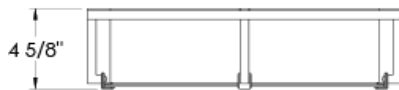

#### DIMENSIONS:

H: 4 5/8" Dia: 18"

#### FINISH SHOWN:

**BZ** Bronze

#### ALSO AVAILABLE IN:

**SN** Satin Nickel

**ANTB** Antique Brass

#### SHADE MATERIAL SHOWN:

Opal Matte Acrylic

#### LAMPING:

(2)  **C13E** 13 Watt Quad Tube Compact  
Fluorescent 4 Pin Electronic, G24Q-1 Base

 **L24-30K** 24 Watts, 3000K LED

 **L18-30K** 18 Watts, 3000K LED, Phase-Cut

Dimming at 120V







# MODEL 2640

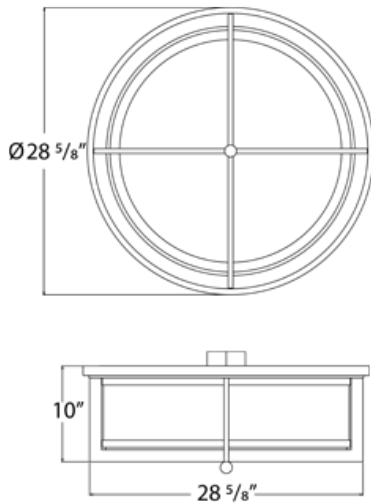

#### DIMENSIONS:

H: 10" Dia: 28 5/8"

#### FINISH SHOWN:

**BZ** Bronze

#### SHADE MATERIAL SHOWN:

Opal Matte Acrylic

#### LAMPING:

(4)  **GU24** Base Socket, for LED A Style Bulb  
or Self-Ballasted CFL

 **L38-30K** 38 Watts, 3000K LED



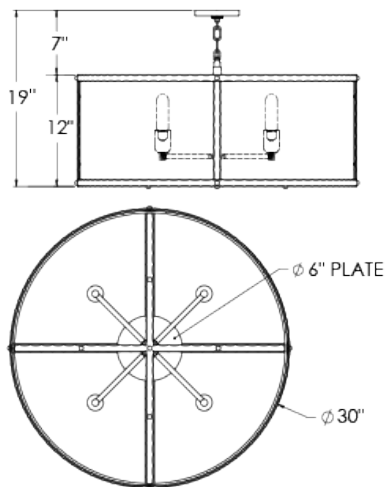

**DIMENSIONS:**

H: 19" Dia: 30 "

**FINISH SHOWN:**

**PDBZ** Powder Coated Bronze

**SHADE MATERIAL SHOWN:**

Gold Organza

**LAMPING:**

(4)  **Medium** Base Socket, for LED A Style Bulb or Self-Ballasted CFL



# MODEL 2663

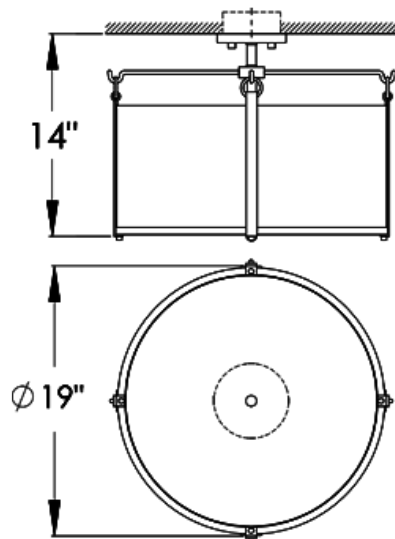

**DIMENSIONS:**

H: 14" Dia: 19"

**FINISH SHOWN:**

**ORBZ** Oil Rubbed Bronze

**SHADE MATERIAL SHOWN:**

Acrylic Diffuser With Laminated Off-White Linen

**LAMPING:**

(4)  **GU24** Base Socket, for LED A Style Bulb  
or Self-Ballasted CFL





# MODEL 2666

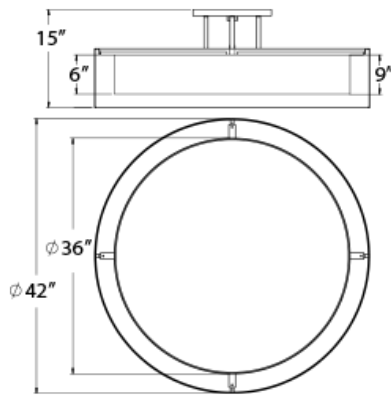

#### DIMENSIONS:

H: 15" Dia: 42"

#### FINISH SHOWN:

Distressed Gold

#### SHADE MATERIAL SHOWN:

Bronze Organza

Hardback CD Ivory with an Opal Matte Acrylic

Bottom Diffuser

#### SHADE SIZE:

H: 9" Dia: 42"

#### LAMPING:

(4)  GU24 Base Socket, for LED A Style Bulb  
or Self-Ballasted CFL





## MODEL 2672

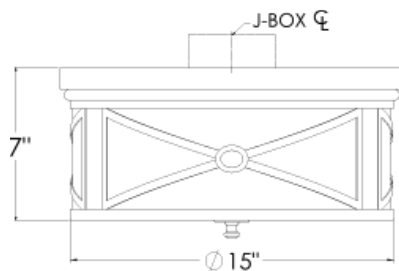

**DIMENSIONS:**

**H:** 7" **Dia:** 15"

**FINISH SHOWN:**

**ANTB** Antique Brass

**ALSO AVAILABLE IN:**

**SN** Satin Nickel

**SDB** Standard Bronze

**SHADE MATERIAL SHOWN:**

Opal Matte Acrylic

**LAMPING:**

**(2)**  **GU24** Base Socket, for LED A Style Bulb  
or Self-Ballasted CFL





# MODEL 2688

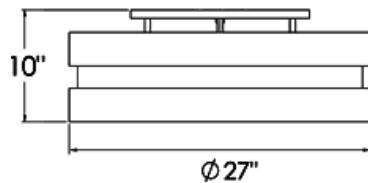

#### DIMENSIONS:

H: 10" Dia: 27"

#### FINISH SHOWN:

**BN** Brushed Nickel

#### SHADE MATERIAL SHOWN:

Linda Black Linen with an Opal Matte Acrylic Bottom Diffuser

#### LAMPING:

(3)  **GU24** Base Socket, for LED A Style Bulb or Self-Ballasted CFL





# MODEL 2695

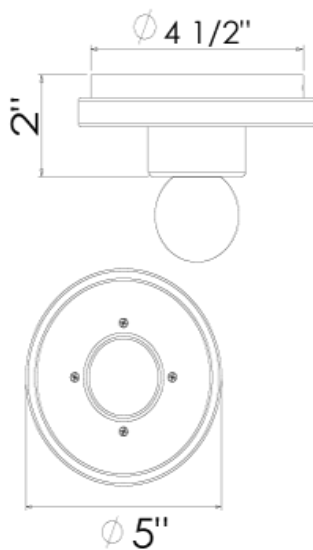

#### DIMENSIONS:

H: 2" Dia: 5"

#### FINISH SHOWN:

**ANTB** Antique Brass

Royal Blue

#### LAMPING:

(1)  **Medium** Base Socket, for LED A Style Bulb or Self-Ballasted CFL







# MODEL 2698

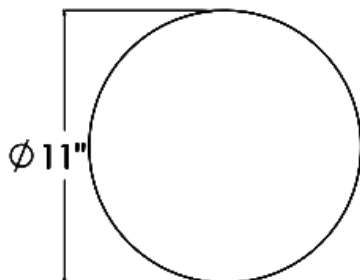
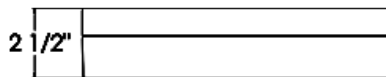

#### DIMENSIONS:

H: 2 1/2" Dia: 11"

#### FINISH SHOWN:

**BZ** Bronze

#### SHADE MATERIAL SHOWN:

Heavy Cast Glass Diffuser with Sprayed Opal Interior

#### LAMPING:

(1)  **Round LED** 1100 Lumens, 3000K







# MODEL 2699

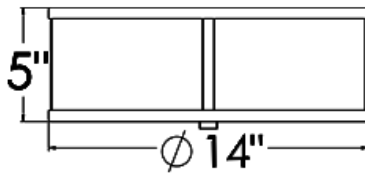

**DIMENSIONS:**

H: 5" Dia: 14"

**FINISH SHOWN:**

**PDMB** Powder Coated Matte Black

**SHADE MATERIAL SHOWN:**

Opal Acrylic Diffuser

**LAMPING:**

(3)  GU24 Base Socket, for 18 Watt Quad CFL





# MODEL 2750

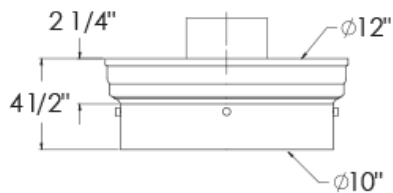

**DIMENSIONS:**

**H: 4 1/2" Dia: 10"**

**FINISH SHOWN:**

**BZ Bronze**

**ALSO AVAILABLE IN:**

**SN Satin Nickel**

**SHADE MATERIAL SHOWN:**

**Opal Matte Glass**

**LAMPING:**

**(2)**  **Medium** Base Socket, for LED A Style Bulb or Self-Ballasted CFL





# MODEL 2755

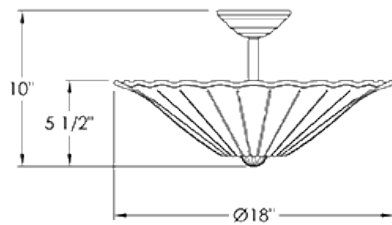

#### DIMENSIONS:

H: 10" Dia: 18"



#### FINISH SHOWN:

**PB** Polished Brass

#### SHADE MATERIAL SHOWN:

Gold Rugiada Glass

#### LAMPING:

- (2)  **C13E** 13 Watt Quad Tube Compact Fluorescent 4 Pin Electronic, G24Q-1 Base
- (2)  **C26E** 26 Watt Quad Tube Compact Fluorescent 4 Pin Electronic, G24Q-3 Base
- (3)  **Medium** Base Socket, for LED A Style Bulb or Self-Ballasted CFL





# MODEL 2757

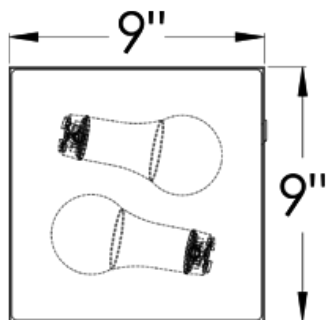
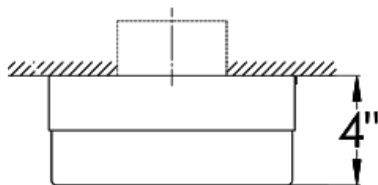

**DIMENSIONS:**

H: 4" D: 9" W: 9"

**FINISH SHOWN:**

SN Satin Nickel

**SHADE MATERIAL SHOWN:**

Opal Matte Acrylic

**LAMPING:**

(2)  GU24 Base Socket, for LED A Style Bulb  
or Self-Ballasted CFL





# MODEL 2759

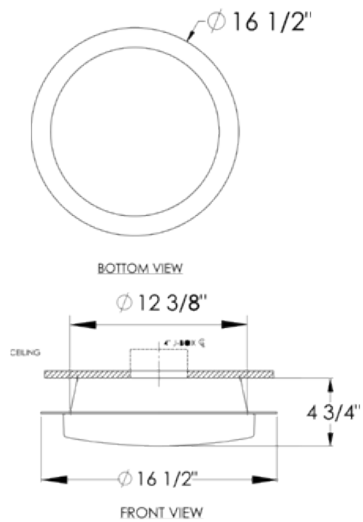

#### DIMENSIONS:

H:  $4 \frac{3}{4}"$  Dia:  $16 \frac{1}{2}"$

#### FINISH SHOWN:

**ANTB** Antique Brass

#### SHADE MATERIAL SHOWN:

Opal Matte Glass

#### SHADE SIZE:

H:  $4 \frac{3}{4}"$  Dia:  $16 \frac{1}{2}"$

#### LAMPING:

(1)  **Medium** Base Socket, for LED A Style Bulb or Self-Ballasted CFL





# MODEL 2766

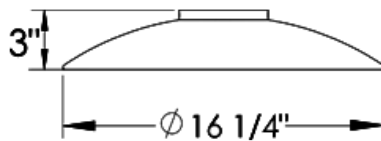

**DIMENSIONS:**

H: 3" Dia: 16 1/4"

**FINISH SHOWN:**

Oak Wood

Matte Black

**SHADE MATERIAL SHOWN:**

Opal Matte Glass

**SHADE SIZE:**

H: 2 1/2" Dia: 16 1/4"

**LAMPING:**

(1)  **GU24** Base Socket, for LED A Style Bulb or Self-Ballasted CFL





# MODEL 2771-4

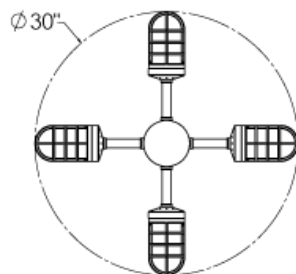
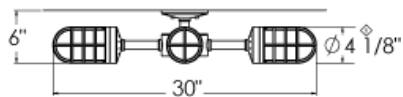

#### DIMENSIONS:

H: 6" Dia: 30"

#### FINISH SHOWN:

Satin Lacquered Brass

#### SHADE MATERIAL SHOWN:

Opal Matte Glass

#### LAMPING:

(4)  GU24 Base Socket, for LED A Style Bulb  
or Self-Ballasted CFL





# MODEL 2786

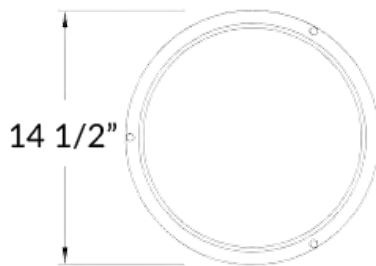

**DIMENSIONS:**

**H:** 4" **Dia:** 14 1/2"

**FINISH SHOWN:**

**ORBZ** Oil Rubbed Bronze

**ALSO AVAILABLE IN:**

**SN** Satin Nickel

**SHADE MATERIAL SHOWN:**

Opal Matte Acrylic

**LAMPING:**

(1)  **FC12T932** 32 Watt Circline T9 Fluorescent  
Lamp

 **L14-30K** 14 Watts, 3000K LED







# MODEL 2788

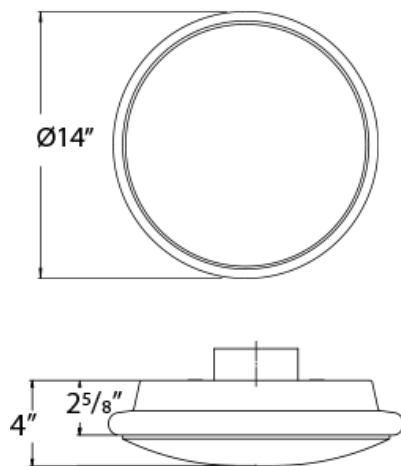

#### DIMENSIONS:

H: 4" Dia: 14"

#### FINISH SHOWN:

**SN** Satin Nickel

#### SHADE MATERIAL SHOWN:

Opal Matte Acrylic

#### LAMPING:

(2)  **C13E** 13 Watt Quad Tube Compact  
Fluorescent 4 Pin Electronic, G24Q-1 Base

(2)  **GU24** Base Socket, for LED A Style Bulb  
or Self-Ballasted CFL

 **L18-30K** 18 Watts, 3000K LED





# MODEL 2789

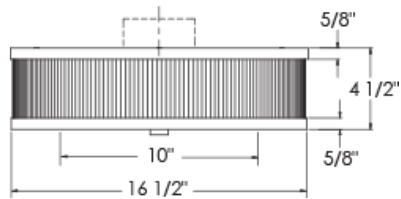

#### DIMENSIONS:

H: 4 1/2" Dia: 16 1/2"

#### FINISH SHOWN:

**PN** Polished Nickel

#### SHADE MATERIAL SHOWN:

Opal Matte Glass

#### LAMPING:

(2)  **GU24** Base Socket, for LED A Style Bulb  
or Self-Ballasted CFL





# MODEL 2795

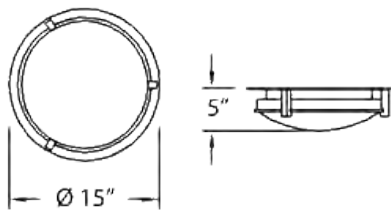

#### DIMENSIONS:

H: 5" Dia: 15"

#### FINISH SHOWN:

**SA** Satin Aluminum

#### SHADE MATERIAL SHOWN:

Opal Matte Glass

#### LAMPING:

(2)  **Medium** Base Socket, for LED A Style Bulb or Self-Ballasted CFL

(2)  **C13E** 13 Watt Quad Tube Compact Fluorescent 4 Pin Electronic, G24Q-1 Base

(2)  **C26E** 26 Watt Quad Tube Compact Fluorescent 4 Pin Electronic, G24Q-3 Base

 **L18-30K** 18 Watts, 3000K LED





# MODEL 2801

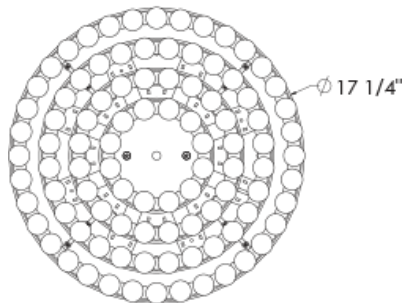
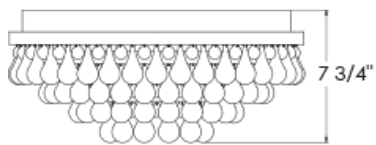

**DIMENSIONS:**

**H:** 7 3/4" **Dia:** 17 1/4"

**FINISH SHOWN:**

**PC Polished Chrome**

**SHADE MATERIAL SHOWN:**

**Tall Clear Glass Pears**

**LAMPING:**

 **L18-27K** 18 Watts, 2700K LED





# MODEL 2811-M1

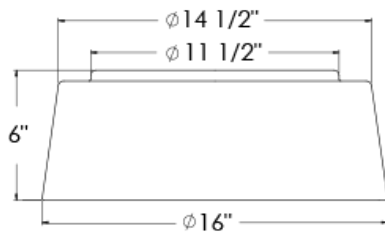

#### DIMENSIONS:

H: 6" Dia: 16"

#### FINISH SHOWN:

Plated Black Satin Nickel

#### SHADE MATERIAL SHOWN:

Opal Matte Acrylic with Incised Grooves Inside

#### LAMPING:

 **L17-30K** 17 Watts, 3000K LED





# MODEL 2812

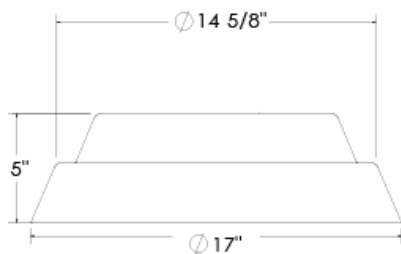

#### DIMENSIONS:

H: 5" Dia: 17"

#### FINISH SHOWN:

**PDBL** Powder Coated Black

Gold Interior

#### SHADE MATERIAL SHOWN:

Opal Matte Glass

#### LAMPING:

(2)  **Medium** Base Socket, for LED A Style  
Bulb or Self-Ballasted CFL

 **L12-30K** 12 Watts, 3000K LED





# MODEL 2815

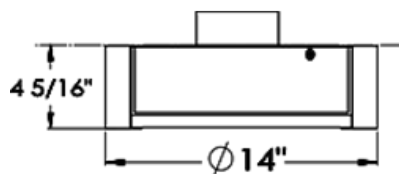

**DIMENSIONS:**

H: 4 5/16" Dia: 14"

**FINISH SHOWN:**

**BZ** Bronze

**SHADE MATERIAL SHOWN:**

Opal Matte Glass

**LAMPING:**

(2)  GU24 Base Socket, for LED A Style Bulb  
or Self-Ballasted CFL





# MODEL 2817

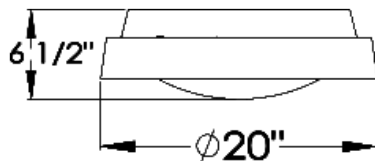

#### DIMENSIONS:

H: 6 1/2" Dia: 20"

#### FINISH SHOWN:

Matte Black

#### SHADE MATERIAL SHOWN:

Opal Acrylic Diffuser

#### LAMPING:

(4)  **Medium** Base Socket, for LED A Style Bulb or Self-Ballasted CFL







# MODEL 2825-M2

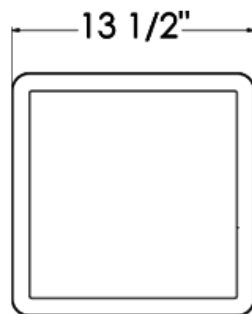

#### DIMENSIONS:

H: 3 3/4" D: 13 1/2" W: 13 1/2"

#### FINISH SHOWN:

**ANTB** Antique Brass

#### SHADE MATERIAL SHOWN:

Opal Matte Glass with Perforated Metal Surround

#### LAMPING:

 **L13-30K** 13 Watts, 3000K LED





# MODEL 2827

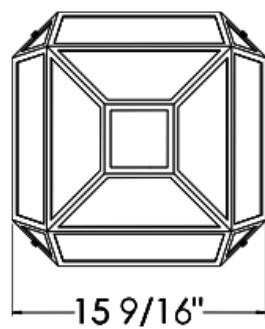
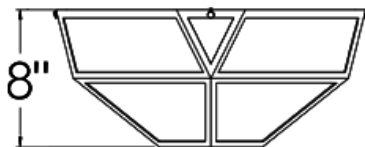

**DIMENSIONS:**

H: 8" D: 15 9/16" W: 15 9/16"

**FINISH SHOWN:**

**BB** Brushed Brass

**SHADE MATERIAL SHOWN:**

Frosted Glass

**LAMPING:**

 **L18-30K** 18 Watts, 3000K LED





# MODEL 2852



#### DIMENSIONS:

H: 5" Dia: 16"

#### FINISH SHOWN:

**SBZ** Satin Bronze

#### ALSO AVAILABLE IN:

**SN** Satin Nickel

**ANTB** Antique Brass

#### SHADE MATERIAL SHOWN:

Opal Matte Acrylic

#### LAMPING:

(2)  **C26E** 26 Watt Quad Tube Compact Fluorescent 4 Pin Electronic, G24Q-3 Base

(3)  **GU24** Base Socket, for LED A Style Bulb or Self-Ballasted CFL

 **L18-30K** 18 Watts, 3000K LED





# MODEL 2866

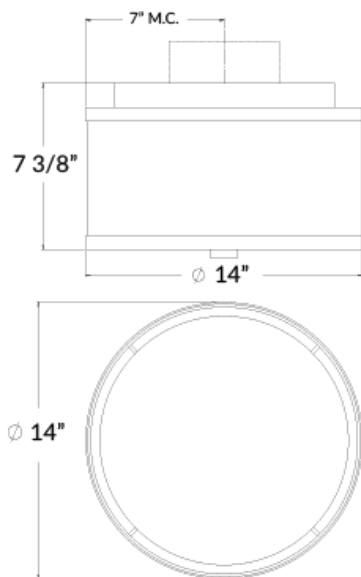

#### DIMENSIONS:

H: 7 3/8" Dia: 14"

#### FINISH SHOWN:

**SN** Satin Nickel

#### ALSO AVAILABLE IN:

**ANTB** Antique Brass

**SDB** Standard Bronze

#### SHADE MATERIAL SHOWN:

Troy Cream Linen

#### SHADE SIZE:

H: 6 1/2" Dia: 14"

#### LAMPING:

(2)  **GU24** Base Socket, for LED A Style Bulb or Self-Ballasted CFL

(2)  **Medium** Base Socket, for LED A Style Bulb or Self-Ballasted CFL

 **L18-30K** 18 Watts, 3000K LED





# MODEL 2871

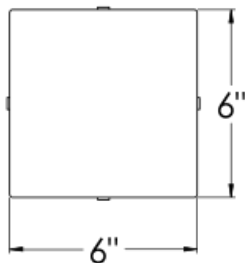
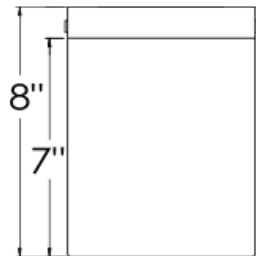

**DIMENSIONS:**

H: 8" D: 6" W: 6"

**FINISH SHOWN:**

**PDB** Powder Coated Brass

**SHADE MATERIAL SHOWN:**

Opal Matte Glass

**LAMPING:**

(1)  **GU24** Base Socket, for LED A Style Bulb  
or Self-Ballasted CFL





# MODEL 2875

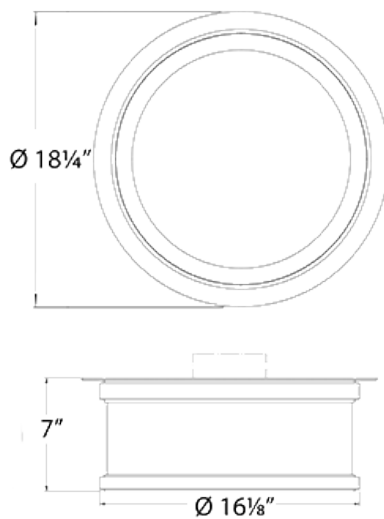

#### DIMENSIONS:

H: 7" Dia: 18 1/4"

#### FINISH SHOWN:

**ABZ** Antique Bronze

#### ALSO AVAILABLE IN:

**SN** Satin Nickel

**ANTB** Antique Brass

#### SHADE MATERIAL SHOWN:

Opal Matte Acrylic

#### LAMPING:

(2)  **C13E** 13 Watt Quad Tube Compact Fluorescent 4 Pin Electronic, G24Q-1 Base

(2)  **GU24** Base Socket, for LED A Style Bulb or Self-Ballasted CFL

 **L24-30K** 24 Watts, 3000K LED





# MODEL 2879-M1

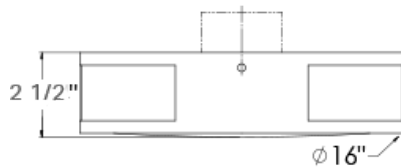

#### DIMENSIONS:

H: 2 1/2" Dia: 16"

#### FINISH SHOWN:

**PDBZ** Powder Coated Bronze

#### SHADE MATERIAL SHOWN:

Opal Acrylic Diffuser

#### LAMPING:

(3)  **L14-35K** 14 Watts, 3500K LED





# MODEL 2879

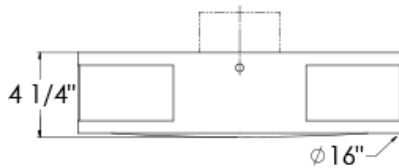

#### DIMENSIONS:

H: 4 1/4" Dia: 16"

#### FINISH SHOWN:

**PDBL** Powder Coated Black

#### SHADE MATERIAL SHOWN:

Opal Matte Acrylic

#### LAMPING:

(2)  **GU24** Base Socket, for LED A Style Bulb  
or Self-Ballasted CFL







# MODEL 2893

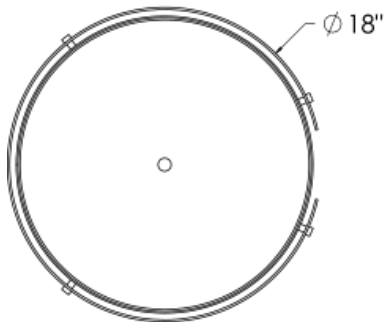
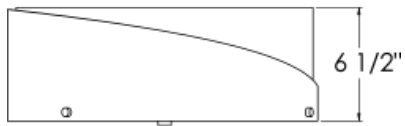

#### DIMENSIONS:

H: 6 1/2" Dia: 18"

#### FINISH SHOWN:

SN Satin Nickel

#### SHADE MATERIAL SHOWN:

Canvas White Linen Acrylic Bottom Diffuser

#### LAMPING:

(3)  GU24 Base Socket, for LED A Style Bulb  
or Self-Ballasted CFL





# MODEL 2919

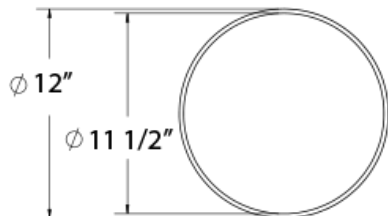
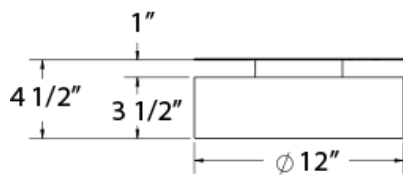

**DIMENSIONS:**

H: 4 1/2" Dia: 12"

**FINISH SHOWN:**

Polished Stainless Steel

**SHADE MATERIAL SHOWN:**

Opal Matte Acrylic

**LAMPING:**

 **L9-27K** 9 Watts, 2700K LED





# MODEL 2933

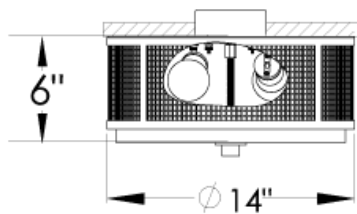
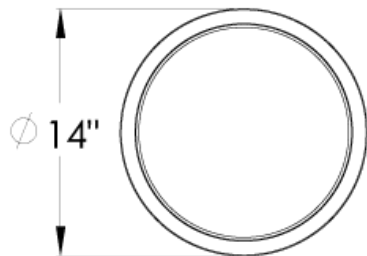

#### DIMENSIONS:

H: 6" Dia: 14"

#### FINISH SHOWN:

Grey Metallic Finish

#### SHADE MATERIAL SHOWN:

Opal Matte Acrylic

#### SHADE SIZE:

H: 6" Dia: 14"

#### LAMPING:

(2)  GU24 Base Socket, for LED A Style Bulb or Self-Ballasted CFL





# MODEL 6273

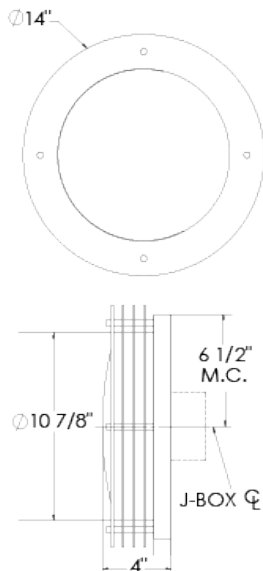

#### DIMENSIONS:

H: 4" Dia: 14"

#### FINISH SHOWN:

**BCH** Brushed Chrome

#### SHADE MATERIAL SHOWN:

Opal Matte Glass

#### LAMPING:

(2)  **C13E** 13 Watt Quad Tube Compact

Fluorescent 4 Pin Electronic, G24Q-1 Base

 **L18-30K** 18 Watts, 3000K LED

